



Spis FST 230V 3-fas

Kokspis och kokpall för restaurang och storkök



4 olika utföranden:

- FST** Fast höjd, fyra ben
- FSTB** Bänkmodell
- FSTH** Höj- och sänkbar med hydraulkolvar
- FSTU** Spis med plats för ugn

Gjutjärnsplattorna, i format 22x22cm, är noggrant monterade och avvägda så att de bildar **en helt plan häll** – ett stort kärl kan ställas över flera plattor samtidigt med full kontakt med underlaget.

STANDARD

- 2, 4, 6 eller 8 plattor.
- Helt i rostfritt.
- Hygienisk.
- Uppfällbara plattor 2000W.
- Utdragbar spillplåt.
- Underhylla.
- Servicevänlig.

TILLVAL

- FSTH kan fås med manuell eller elektrisk höjjustering.
- Gallerhylla undertill.
- Fronthylla.
- Sidohylla.
- Överhylla med eller utan blandare.
- Spisar marint bruk, 230V/400V/440V/480V.
- Slingerräcke, marint bruk.
- Spisar enligt önskemål.

Rejäl • Snabb • Driftsäker • Kraftfull • Slitstark

MÅTTSKISSER

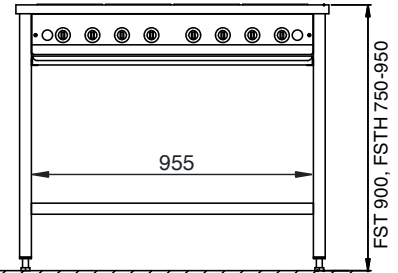
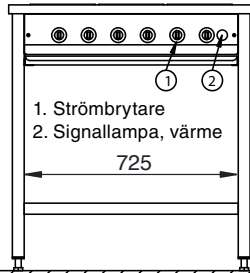
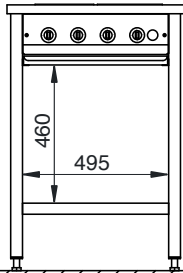
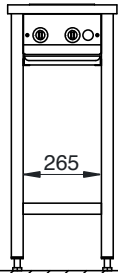
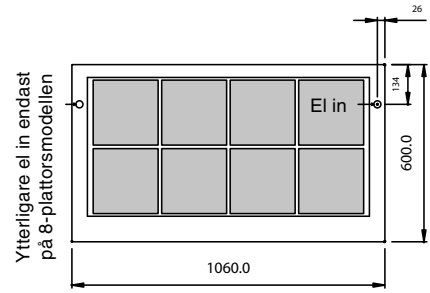
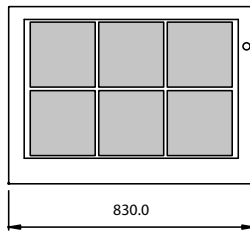
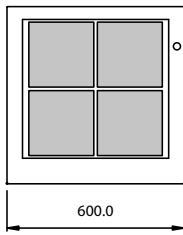
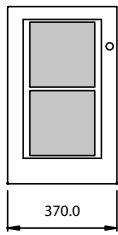

FST/FSTH
2190

FST/FSTH
4090

FST/FSTH
6090

FST/FSTH
8090

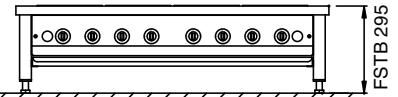
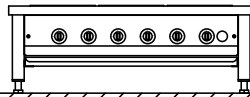
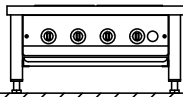
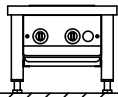

FSTB
2129

FSTB
4029

FSTB
6029

FSTB 8029

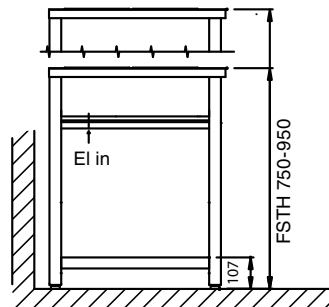
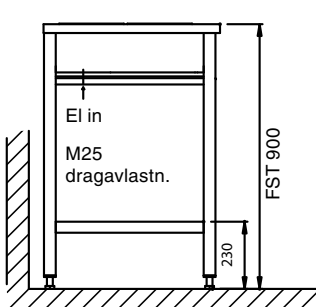
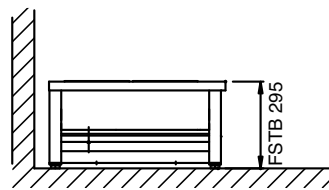
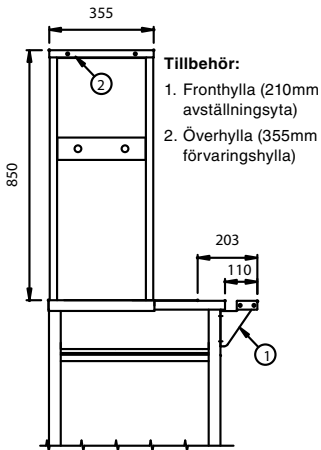

TEKNISKA DATA

Modell (xx29 / xx90)	Antal plattor	Effekt (kW)	Säkring (A)	Vikt (kg)
FST 21xx	2	4	16	55
FST 40xx	4	8	32	70
FST 60xx	6	12	32	95
FST 80xx	8	16	2x32	130

Ovan specifikation avsedd för 3-fas 230V, 50Hz.
Vikt avser xx90-modellerna.